

Steel Composite Bridge Wizard

For LUSAS version:	21.0
For software product(s):	LUSAS <i>Civil & Structural</i> or LUSAS <i>Bridge</i> .
With product option(s):	None (if building a model for solely analysis) Composite Bridge Deck Design (if preparing a model for a design check)
Note: This example exceeds the limits of the LUSAS Teaching and Training Version.	

Description

This example illustrates how to create a beam and shell model of a steel composite bridge using the Steel Composite Bridge Wizard. The bridge consists of three spans of length 80 feet, 100 feet and 80 feet, all measured along a control centreline of 600 feet radius. All supports are along radials.

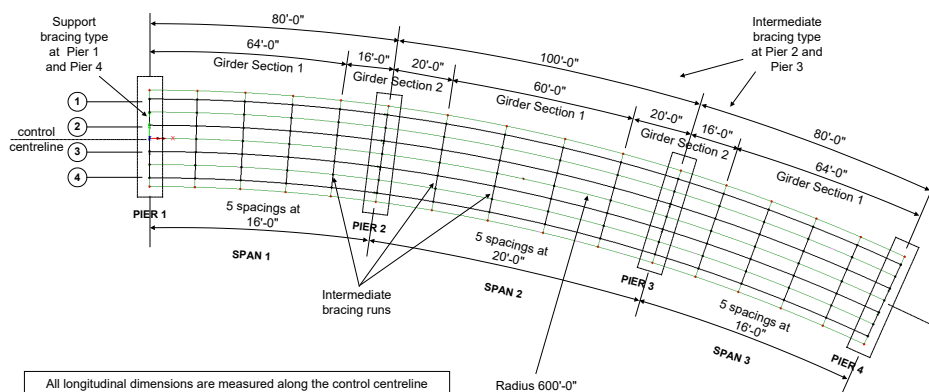

Four girders form each span, with support and intermediate bracing between them as shown on the image above. Lateral restraint is provided to the two internal girders at each support. Longitudinal restraint is provided to all four girders at pier 3. Transverse

girder spacing and slab cantilever dimensions are shown on the following image, which also shows the modelling methodology used.

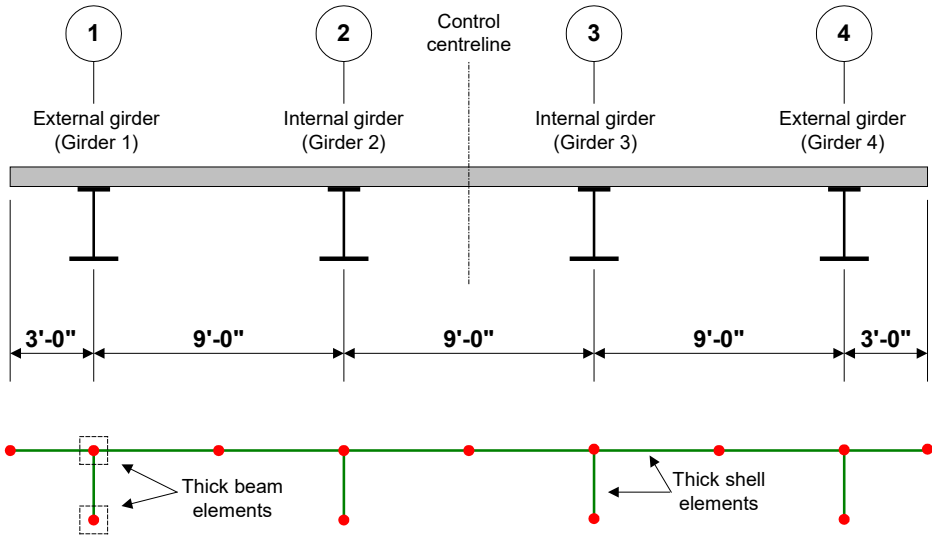

Girder and slab thickness are as follows:

	External girder section 1	Internal girder section 1	External girder section 2	Internal girder section 2
Slab width	7'6"	9'0"	7'6"	9'0"
Slab thickness	8"	8"	8"	8"
Slab height of haunch	1.5"	1.5"	1.5"	1.5"
Slab offset to web	-9"	0"	-9"	0"
Top flange width	18"	18"	18"	18"
Top flange thickness	0.75"	0.75"	1.0"	1.0"
Web depth	4'0"	4'0"	4'0"	4'0"
Web thickness	0.5"	0.5"	0.5"	0.5"
Bottom flange width	24"	24"	24"	24"
Bottom flange thickness	1"	1"	1.5"	1.5"

The loading on this model is limited to just Gravity.

Units used are kip,ft,kslug,s,F throughout.

Objectives

- ❑ Part 1: Create a beam and shell model using the Steel Composite Bridge Wizard, add bracing and generate results using the Beam/Shell slicing facility.
- ❑ Part 2: To extend the model by defining design attributes in preparation for a design check to supported codes.

Keywords

3D, Steel, Concrete, Composite, Bridge, Structural, Wizard, AASHTO 8th Edition, Design Attribute, Beam/Shell Slicing.

Associated Files

Associated files can be downloaded from the user area of the LUSAS website.

- ❑ **steel_composite_bridge_wizard.lvb** creates a model that has been previously defined and built by the wizard. It is supplied in case of user errors in creating a model as described in this example and allows for viewing and investigation of all utilities and attributes created by the wizard. All bridge wizard utilities, excluding stiffener and bracing details, have been defined. No design details are present.
- ❑ **steel_composite_bridge_wizard_braced.lvb** creates a model that includes all bridge wizard utilities as well as stiffener and bracing details. No design details are present.

Associated Examples

- ❑ The worked example '*Staged construction modelling of a 3-span bridge deck*' shows how to model loading on the bridge during the construction stages and in-service conditions under traffic loads.
- ❑ The worked example '*Composite Bridge Deck Design*' shows how to carry out a design check of a staged construction model of a 3-span bridge deck.

Running LUSAS Modeller

For details of how to run LUSAS Modeller, see the heading *Running LUSAS Modeller* in the *Introduction to LUSAS Worked Examples* document.



Note. This example is written assuming a new LUSAS Modeller session has been started. If continuing from an existing Modeller session select the menu command

File>New to start a new model file. Modeller will prompt for any unsaved data and display the New Model dialog.

Creating a new model

- Enter a file name of **Steel_Composite_Bridge**
- Use the default **User-defined** working folder.
- Ensure an Analysis type of **Structural** is set.
- Set an Analysis Category of **3D**
- Set Model units of **kip,ft,kslug,s,F**
- Leave the Timescale units as **Seconds**
- Ensure the Startup template is set as **None**
- Ensure the Layout grid is set as **None**
- Enter a Title of **Three span steel composite bridge**
- Click the **OK** button.

File
New...

Part 1: Defining bridge geometry using the Composite Bridge Wizard

The bridge geometry and many of the attributes will be created using the Steel Composite Bridge Wizard. As the various menu items of the wizard are visited, utilities are created in the Utilities  treeview. These utilities are ultimately used to generate the geometry and attributes of the steel composite bridge model when it is decided to do so.

Since a bridge is made of spans and supports, and a span is made of girders and bracing runs, and a girder is made of sections and stiffeners, the smallest components (sections) are best defined first, because they can then be referenced directly by the next component up in the hierarchy (girders), and so on, until the final bridge 'definition' is specified.

Initially, the basic bridge geometry (without stiffeners or bracing) is defined. This allows a model to be created for visualisation and checking purposes prior to then adding more details such as transverse stiffeners and bracing assemblies by re-visiting the wizard.

Defining Composite I-Girder Sections

Four I-girder sections are to be defined; one for each change of section in the internal and external girders.

Defining section 1 (internal girder)

Bridge	
Steel Composite	
Bridge Wizard	>
Composite I-	
Girder Section...	

- On the drop list for Slab Material select **New**
- On the dialog that appears ensure that the Material is set to **Concrete**, the region is set to **USA**, Standard is **AASHTO LRFD 8-9th** and Grade is **4.0ksi**. Change the name to **Concrete** and select **OK**.



Note. In this example, model units were specified as feet, but some values (such as thicknesses) are best entered in inches. To signify inches, the symbol for inches (") needs to be appended to the value entered. Alternatively, the Unit convertor could be used.

- For the Slab Width, enter a value of **9** (by default this will be interpreted in model units of 'feet' and will be re-displayed in feet and inch format whenever the dialog is re-displayed)
- For the Thickness of the slab, enter a value of **8"** (the symbol for inches needs to be added to signify this value)
- For the Height of haunch, enter a value of **1.5"**
- Leave the values for 'Offset to web' as **0**
- On the drop list for Top Flange Material select **New**
- On the dialog that appears ensure that material is set to **Steel-Structural**, the region is set to **USA**, Standard is **AASHTO LRFD 4th-9th** and Grade is **Ungraded**. Change the name to **Steel** and select **OK**.



Note. Defining this steel material will populate the material droplists for the Web and Bottom Flange as well.

- Enter the Width of the Top Flange as **18"** and the Thickness as **0.75"**.
- Enter the Depth of the Web as **4** and the Thickness as **0.5"**.
- Enter the Width of the Bottom Flange as **24"** and the Thickness as **1"**.



Note. For those with a software licence that supports the Composite Bridge Deck Design software option, a Bridge Design Material attribute could also be defined at this stage, but for simplicity this will be done as a separate exercise in Part 2 of this example.

Steel Composite Bridge Wizard - Composite I-Girder Section

Slab
Material: 1:Concrete (4.0ksi | Concrete | AASHTO LRFD 8th)
Width: 9 Thickness: 8.0"
Height of haunch: 1.5" Offset from web: 0

Top flange
Material: 2:Steel (Ungraded | Steel - Structural | AASHTO LRFD 4th)
Width: 18" Thickness: 0.75"

Web
Material: 2:Steel (Ungraded | Steel - Structural | AASHTO LRFD 4th)
Depth: 4 Thickness: 0.5"

Bottom flange
Bottom Flange: 2:Steel (Ungraded | Steel - Structural | AASHTO LRFD 4th)
Width: 24" Thickness: 1"

Design
 Bridge design material: None defined

Name: Section 1 internal (new)

OK Cancel Apply Help

- Enter the section name as **Section 1 internal** and click **Apply**.

A section utility will be created in the Utilities  treeview.

Defining section 1 (external girder)

- On the Composite I-Girder Section dialog change the section name to be **Section 1 external**
- Change the Slab Width to **7.5**
- Change the Slab Offset from Web to **-9"**

Part 1: Defining bridge geometry using the Composite Bridge Wizard

Steel Composite Bridge Wizard - Composite I-Girder Section

Slab
Material: 1:Concrete (4.0ksi | Concrete | AASHTO LRFD 8th)
Width: 7.5 Thickness: 8"
Height of haunch: 1.5" Offset from web: -9"

Top flange
Material: 2:Steel (Ungraded | Steel - Structural | AASHTO LRFD 4th)
Width: 18" Thickness: 0.75"

Web
Material: 2:Steel (Ungraded | Steel - Structural | AASHTO LRFD 4th)
Depth: 4 Thickness: 0.5"

Bottom flange
Bottom Flange: 2:Steel (Ungraded | Steel - Structural | AASHTO LRFD 4th)
Width: 24" Thickness: 1"

Design
 Bridge design material: None defined

Name: Section 1 external (new)

OK Cancel Apply Help

- Leave all other settings as they are and click **Apply**.



Note. Values of equal to, or greater than 12 inches, if entered in inches, will be converted to values in feet and inches when the dialog is re-displayed.

The utilities already created will now be edited to define additional sections.

Defining section 2 (internal girder)

- In the  treeview double-click on the utility **Section 1 internal**.
- On the Composite I-Girder Section dialog change the section name to be **Section 2 internal**
- Change the thickness of the top flange to **1"**.
- Change the thickness of the bottom flange to **1.5"**.

Steel Composite Bridge Wizard - Composite I-Girder Section

Slab

Material: 1:Concrete (4.0ksi | Concrete | AASHTO LRFD 8th)

Width: 9' 0" Thickness: 8.0"

Height of haunch: 1.5" Offset from web: 0

Top flange

Material: 2:Steel (Ungraded | Steel - Structural | AASHTO LRFD 4th)

Width: 1' 6.0" Thickness: 1"

Web

Material: 2:Steel (Ungraded | Steel - Structural | AASHTO LRFD 4th)

Depth: 4' 0" Thickness: 0.5"

Bottom flange

Bottom Flange: 2:Steel (Ungraded | Steel - Structural | AASHTO LRFD 4th)

Width: 2' 0" Thickness: 1.5"

Design

Bridge design material: None defined

Name: Section 2 internal (3)

OK Cancel Apply Help

- Leave all other settings as they are and click **Apply**.

Defining section 2 (external girder)

- On the Composite I-Girder Section dialog change the section name to be **Section 2 external**
- Change the Slab Width to **7.5**
- Change the Slab Offset from Web to **-9"**

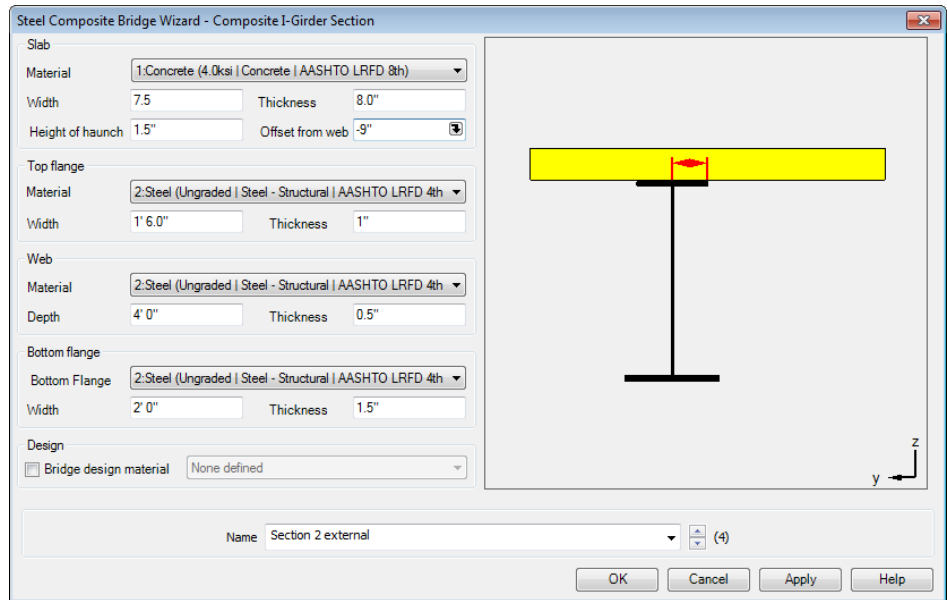

- Leave all other settings as they are and click **OK**.

This completes the creation of the Composite I-Girder Section utilities. These will now be used as part of defining the girders.

Defining Girders

Two girder utilities are required: one for the end span and one for the internal span.

Internal girder for span 1

The internal girder to span 1 utility is now to be created.

- Click in the Position cell and enter a value of **0**
- From the droplist for Section select **Section 1 internal**.
- Set the Interpolation mode to **Step**.



Note. The option ‘Step’ causes the section to change abruptly at the stated position. ‘Linear’ tapers between the section and the previous section

- Right click in the Sections panel and select **Add row**.
- Click in the Position cell and enter a value of **64**
- From the droplist for Section select **Section 2 internal**.
- Set the Interpolation Mode to **Step**.

Bridge
Steel Composite
Bridge Wizard >
Girder...

Sections			
	Position	Section	Interpolation mode
	0	1:Section 1 internal	Step
▶	64	3:Section 2 internal	Step ▼

- Enter the utility name as **Internal Girder Span 1** and click **Apply**.

External girder for span 1

- Change the Section on the first row of the grid to **Section 1 external** and the second row to **Section 2 external**.

Sections			
	Position	Section	Interpolation mode
	0	2:Section 1 external	Step
▶	64	4:Section 2 external	Step ▼

- Enter the utility name as **External Girder Span 1** and click **Apply**.

Internal girder for span 2

- Change the Section on the first row of the grid to **Section 2 internal**.
- Change the Position on the second row of the grid to **20** and the Section to **Section 1 internal**
- Right-click in the Sections panel and select **Add row**.
- Enter the position as **80**, the Section as **Section 2 internal** and the Interpolation Mode as **Step**.

Sections			
	Position	Section	Interpolation mode
	0	3:Section 2 internal	Step
	20	1:Section 1 internal	Step
⋮	80	3:Section 2 internal ▼	Step

- Enter the utility name as **Internal Girder Span 2** and click **Apply**.

External girder for span 2

- Change the Section on the first row of the grid to **Section 2 external**, on the second row of the grid to **Section 1 external** and on the third row of the grid to **Section 2 external**.

Sections			
	Position	Section	Interpolation mode
	0	4:Section 2 external	Step
	20	2:Section 1 external	Step
▶	80	4:Section 2 external	Step ▼

- Enter the utility name as **External Girder Span 2** and click **OK**.

This completes the creation of the Girder utilities. These will now be used as part of defining the spans.

Defining spans

Only two span utilities need to be defined – for span 1 and for span 2. When defining the bridge, span 1 will be reversed to create span 3.

Span 1

Bridge	
Steel Composite	
Bridge Wizard	>
Span...	

- Click in the Girder cell and a droplist of the previously created girders appears. Select **External Girder Span 1**.
- Right click in the Girders panel and select **Add Row**. Repeat twice.
- Click in the Girder cell of the second row and from the droplist select **Internal Girder Span 1**. Repeat for the third row.
- Click in the cell of the fourth row and from the droplist select **External Girder Span 1**. Tick the check box **Mirror girder about web**.

Girders			
	ID	Girder	Mirror girder about web
▶	1	2:External Girder Span 1	<input type="checkbox"/>
	2	1:Internal Girder Span 1	<input type="checkbox"/>
	3	1:Internal Girder Span 1	<input type="checkbox"/>
	4	2:External Girder Span 1	<input checked="" type="checkbox"/>

- Enter the utility name as **Span 1** and click **Apply**.

Span 2

- Change the girder entry in the first row to **External Girder Span 2**.
- Change the girder entry in the second and third rows to **Internal Girder Span 2**.
- Change the girder entry in the last row to **External Girder Span 2**. Leave the Mirror girder about web check box ticked.

Girders			
	ID	Girder	Mirror girder about web
▶	1	4:External Girder Span 2	<input type="checkbox"/>
	2	3:Internal Girder Span 2	<input type="checkbox"/>
	3	3:Internal Girder Span 2	<input type="checkbox"/>
	4	4:External Girder Span 2	<input checked="" type="checkbox"/>

- Enter the utility name as **Span 2** and click **OK**.

This completes the creation of the Span utilities.



Note. Bracing runs between spans could also be created at this stage but for this example they will be added after the primary geometry has been created.

Defining supports

Three different support types need defining.

End Pier

- Select the check box for **Vertical support** for girder numbers **1, 2, 3** and **4**.
- Select the check box for **Transverse support** for girders **2** and **3**.

Girders				
Girder number	Longitudinal support	Transverse support	Vertical support	
1	<input type="checkbox"/>	<input type="checkbox"/>	<input checked="" type="checkbox"/>	
2	<input type="checkbox"/>	<input checked="" type="checkbox"/>	<input checked="" type="checkbox"/>	
▶ 3	<input type="checkbox"/>	<input checked="" type="checkbox"/>	<input checked="" type="checkbox"/>	
4	<input type="checkbox"/>	<input type="checkbox"/>	<input checked="" type="checkbox"/>	

Skew
0.0000 degrees

Bracing orientation
Skew

- Enter the utility name as **End Pier** and click **Apply**.

Bridge	
Steel Composite	
Bridge Wizard	>
Support...	

Internal Pier 1

- Enter the utility name as **Internal Pier 1** and click **Apply**.

Internal Pier 2

- Select the check box for **Longitudinal support** to girders **1, 2, 3** and **4**.

Girders				
	Girder number	Longitudinal support	Transverse support	Vertical support
	1	<input checked="" type="checkbox"/>	<input type="checkbox"/>	<input checked="" type="checkbox"/>
	2	<input checked="" type="checkbox"/>	<input checked="" type="checkbox"/>	<input checked="" type="checkbox"/>
	3	<input checked="" type="checkbox"/>	<input checked="" type="checkbox"/>	<input checked="" type="checkbox"/>
	4	<input checked="" type="checkbox"/>	<input type="checkbox"/>	<input checked="" type="checkbox"/>

Skew: 0.0000 degrees

Bracing orientation: Skew

- Enter the utility name as **Internal Pier 2** and click **OK**.



Note. The End Pier and Internal Pier 1 supports as currently defined are the same – this will change when support bracing is added. Support bracing could also be created at this stage but for this example it will be added after the primary geometry has been created.

This completes the creation of the Support utilities. These will now be used in the definition of the bridge as a whole.

Defining the Bridge utility

Straight and Curved bridge types are supported by the wizard.

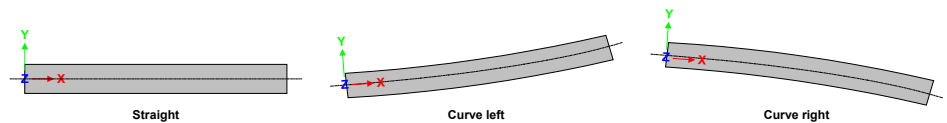

For this example, a 'Curve right' bridge type is to be defined.

Bridge
 Steel Composite
 Bridge Wizard >
 Bridge...

- Select the **Curve Right** radio button. Insert a value of **600** in the Radius test box.
- Set the mesh size to be **2**.
- In the Spans grid click in the span cell on the first row. Choose **Span 1** from the droplist.
- In the Length cell enter a value of **80**.
- Right click in the Spans panel and select **Add Row**. Repeat once.
- In the Span cell on the second row choose **Span 2**. In the Length cell enter a value of **100**.

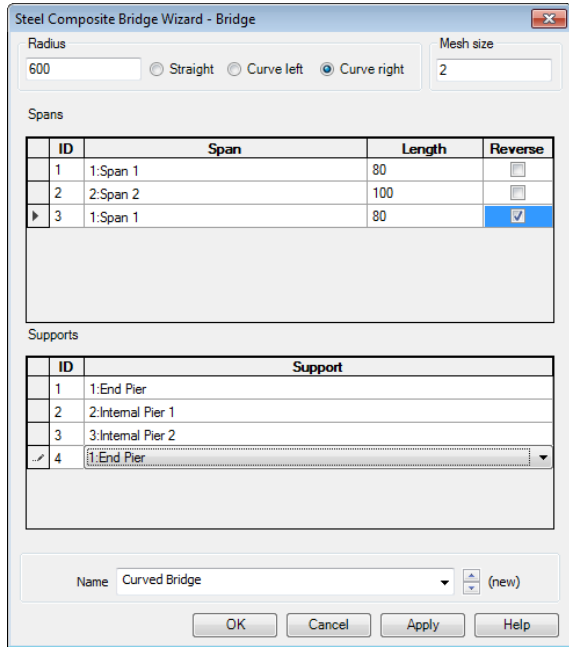

- In the Span cell choose on the third row choose **Span 1**. In the Length cell enter a value of **80**.
- Tick the **Reverse** checkbox.
- In the Supports grid click in the Support cell of row 1. Choose **End Pier** from the droplist.
- Similarly add **Internal Pier 1** to row 2, **Internal Pier 2** to row 3, and **End Pier** to row 4.
- Enter the bridge utility name as **Curved Bridge** and click **OK**.

Generating the bridge

Finally, after defining the constituent parts of the bridge, the model can be generated from the Steel Composite Bridge utilities that are present in the Utilities  treeview.

- On the dialog that appears press the **Generate** button.

After a period of time the bridge is created with the required geometry, features, mesh, geometric, material and support attributes.

Bridge
 Steel Composite
 Bridge Wizard >
 Generate defined
 bridge...

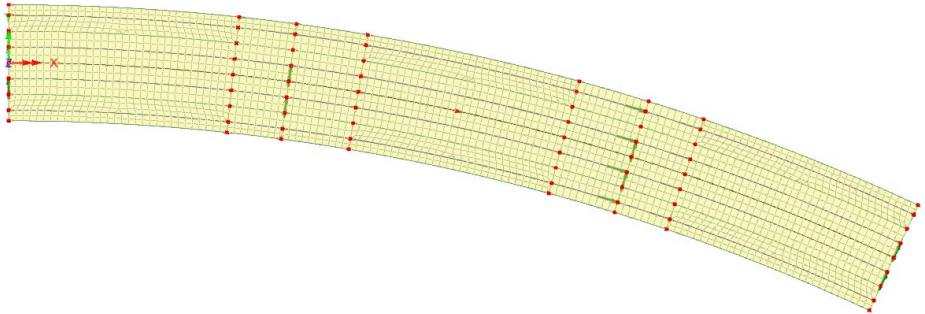

If the bridge generation fails...

If the bridge cannot be generated from the data defined, information relating to the nature of the error encountered will be displayed on screen. Any issues should be corrected by opening the relevant bridge wizard utilities, then saving the model and attempting to re-generate the bridge. If the errors cannot be identified or overcome, a replacement model can be created from a supplied file in order to solve and view results.

Creating a replacement model

A file is provided to allow you to create a replacement model and view and investigate all utilities and attributes created by the wizard. You may download this file from the user area of the LUSAS website.



steel_composite_bridge_wizard.lvb

Creating a replacement model

- Enter a file name of **steel_composite_bridge**
- Use the default **User-defined** working folder.
- Ensure an Analysis type of **Structural** is set.
- Ensure an Analysis category of **3D** is set.
- Click the **OK** button.



Note. There is no need to enter any other new model details when the intention is to run a script to build an initial model, since the contents of the script will overwrite any other settings made.

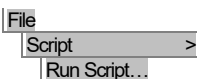



-  To create the model, open the file **steel_composite_bridge_wizard.lvb** that was downloaded and placed in a folder of your choosing.



Note. The supplied model includes all bridge wizard utilities but excludes all bracing and stiffener details as these will be defined in the next section. Once the model has been created, continue from the previous heading ‘Generating the Bridge’.

When the bridge has been successfully generated

-  Choose an isometric view of the model to see the generated features, mesh and supports.
-  Turn on fleshing.
-  Turn on ‘Fleshing all transparent’.

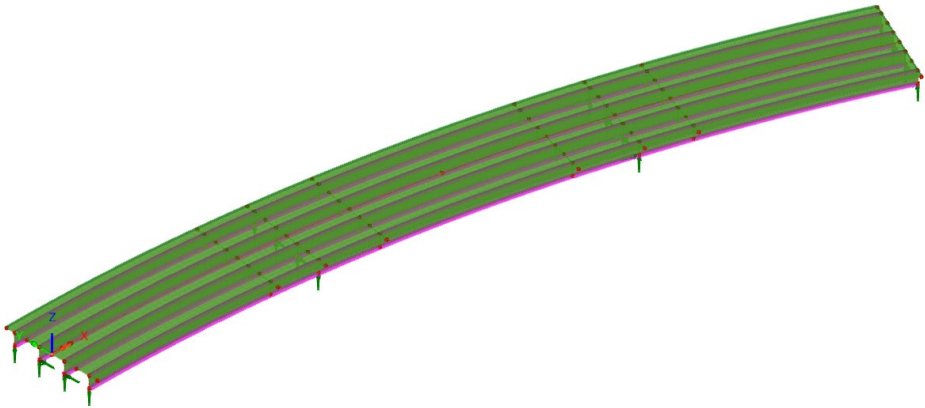

Note. Defining the basic bridge geometry (without stiffeners or bracing) allows a model to be created for visualisation and checking purposes prior to then adding more detail by re-visiting the wizard.

Add stiffeners and bracing to the model

Defining Transverse Stiffeners

Stiffeners will be defined for use at all bracing locations. These are defined as being to the left or right of the girder web, dependent upon the girder line axes.

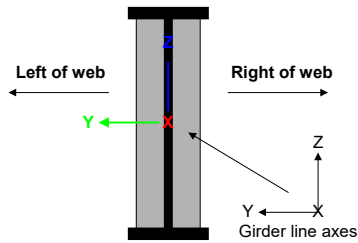

Bridge
 Steel Composite
 Bridge Wizard >
 Transverse
 Stiffener...

- Click in the Outstand width cell and enter a value of **8"**.
- Click in the Thickness cell and enter a value of **0.375"**.
- Set the Longitudinal offset to **0**.
- Click in the **Side of web** cell and choose **Left** from the droplist.



Note. For those with a software licence that supports the Composite Bridge Deck Design software option, a Design attribute for stiffener design could be defined at this stage, but this will be covered in Part 2 of the example.

Steel Composite Bridge Wizard - Transverse Stiffener ✕

	Outstand width	Thickness	Longitudinal offset	Side of web
▶	8.0"	0.375"	0	Left

Material: 2:Steel (Ungraded | Steel - Structural | AASHTO LRFD 4th-9th) ▼

Design

Bridge design stiffener: 1:Transverse stiffener 1 ▼

Use bridge design stiffener as this definition

Name: Left of web stiffener ▼ ▲ (new)

- Enter the name of the stiffener utility to be **Left of web stiffener** and click **Apply**.
- Change the Side of web to **Right**.
- Change the stiffener utility name to be **Right of web stiffener**

- Click **OK**.

These stiffeners will be referenced when defining the bracing.



Note. If the ‘Use bridge design stiffener as this stiffener’ option (which is only enabled if the Bridge design stiffener check box is selected) is selected, outstand, thickness and longitudinal offset values from the design stiffener are used to populate the grid. This is not to be selected for this example.

Bracing Assembly

Bracing assemblies are used to define intermediate bracing runs and bracing at supports. Bracing section size, material and configuration type needs to be specified.

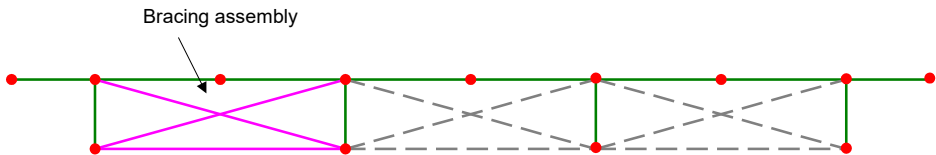

Intermediate bracing

An intermediate bracing assembly as shown in the above image will be defined.

- Click in the **Section** cell. From the droplist click **New**. On the Geometric Line attribute dialog that appears choose **US Sections, Single Angles (L) (AISC14), L6X6X1/2**. Click **OK**.
- Back on the Bracing Assembly dialog, click in the **Material** cell and choose **Steel**.
- For the ‘From’ and ‘Of’ locations, select **Top of web** and **Left girder**, and for the ‘To’ and ‘Of’ locations, select **Bottom of web** and **Right girder**
- Right-click anywhere in the bracing assembly panel and select **Add Row**.
- Choose the same Section and Material as before.
- For the ‘From’ and ‘Of’ locations, select **Bottom of web** and **Left girder**, and for the ‘To’ and ‘Of’ locations, select **Top of web** and **Right girder**
- Add another row.
- Choose the same Section and Material as before.
- For the ‘From’ and ‘Of’ locations, select **Bottom of web** and **Left girder**, and for the ‘To’ and ‘Of’ locations, select **Bottom of web** and **Right girder**

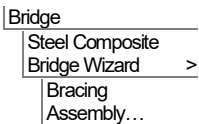

Girder stiffeners that will apply at these bracing assembly locations are referenced with respect to the left or right of the pair of girders between which the bracing will occur. The schematic diagram on the dialog shows which side of a bridge model is considered to be the 'Left' side and which is the 'Right' side with respect to the direction of the control centreline.

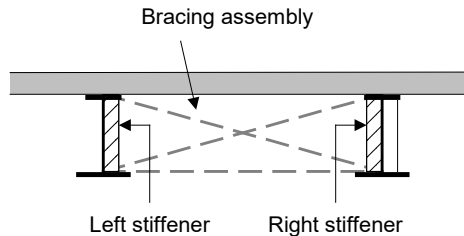

The left and right stiffener types for the bracing assembly (as shown on the previous image) must be specified using the drop-lists provided.

- From the droplist for the Left stiffener choose **Right of web stiffener**.
- From the droplist for the Right stiffener choose **Left of web stiffener**.

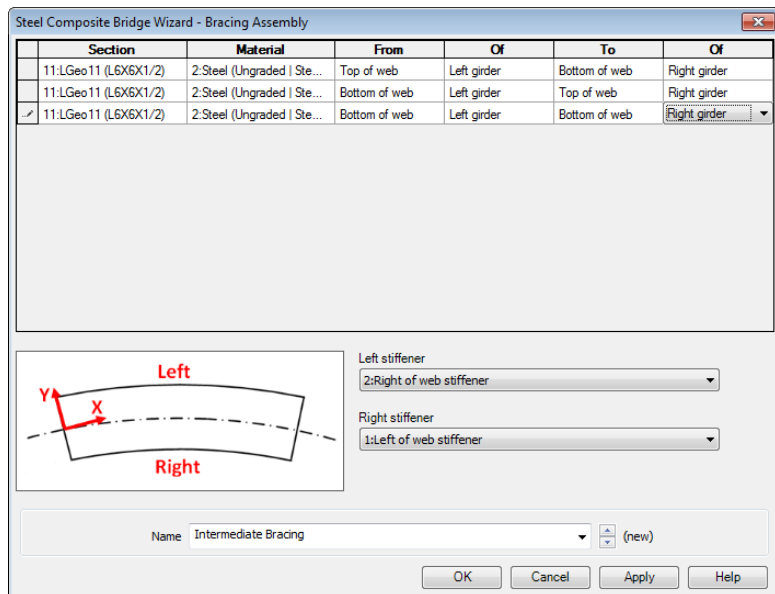

- Enter the bracing assembly utility name as **Intermediate Bracing** and click **Apply**.

Support bracing

K-bracing will be defined for support locations.

- Click in the Section cell on the first row. From the droplist click **New**. On the Geometric Line attribute dialog that appears choose **US Sections, Standard Channels (C) (AISC14), C10X20**. Click **OK**.

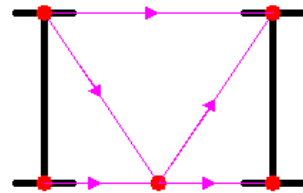

- Modify and add new rows to the grid as shown on the following image to define the K-bracing assembly.

	Section	Material	From	Of	To	Of
	12:LGeo12 (C10X20)	2:Steel (Ungraded Ste...	Top of web	Left girder	Top of web	Right girder
	11:LGeo11 (L6X6X1/2)	2:Steel (Ungraded Ste...	Top of web	Left girder	Bottom of web	Mid-point
	11:LGeo11 (L6X6X1/2)	2:Steel (Ungraded Ste...	Bottom of web	Mid-point	Top of web	Right girder
	11:LGeo11 (L6X6X1/2)	2:Steel (Ungraded Ste...	Bottom of web	Left girder	Bottom of web	Mid-point
	11:LGeo11 (L6X6X1/2)	2:Steel (Ungraded Ste...	Bottom of web	Mid-point	Bottom of web	Right girder

- Enter the bracing assembly utility name as **Support Bracing** and click **OK**.

Intermediate Bracing Run

The distances at which selected bracing assemblies are positioned along the control centreline and bracing orientation type need to be stated. Distances are specified in absolute values with respect to the start of each span, as per the following image which shows an elevation of the bridge:

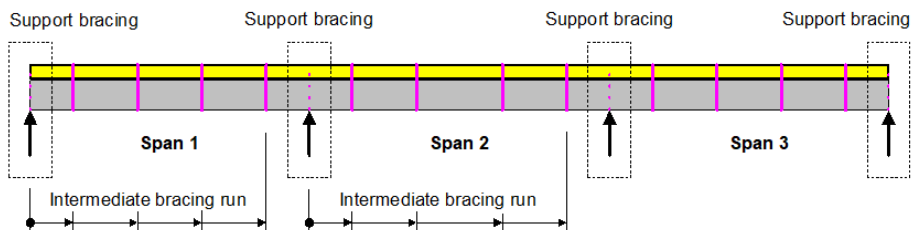

Span 1 bracing

- Click in the Location cell and enter a value of **16**.
- Click in the Bracing Assembly cell and select **Intermediate bracing**.
- Click in the Orientation cell and select **Square**.
- Right-click in the Bracing Run panel and select **Add Row**. Repeat twice more.

Bridge	
Steel Composite	
Bridge Wizard	>
Intermediate	
Bracing Run...	

- Enter a value of **32** in the Location cell and make the same settings as previously done for the Bracing Assembly and Orientation.
- Similarly enter values of **48** and **64** respectively and make the same settings for the remaining rows.

	Location	Bracing assembly	Orientation
	16	1:Intermediate Bracing	Square
	32	1:Intermediate Bracing	Square
	48	1:Intermediate Bracing	Square
	64	1:Intermediate Bracing	Square

- Enter the utility name as **Span 1 Bracing** and click **Apply**.

Span 2 bracing

- Change the values in the Location cells to **20, 40, 60** and **80** respectively.

	Location	Bracing assembly	Orientation
	20	1:Intermediate Bracing	Square
	40	1:Intermediate Bracing	Square
	60	1:Intermediate Bracing	Square
	80	1:Intermediate Bracing	Square

- Enter the utility name as **Span 2 Bracing** and click **OK**.

Assigning the Bracing Runs to Spans

- In the  treeview double click on the Span utility **Span 1** to open the Span dialog.
- In the Bracing Runs panel, click in the Bracing Run cell in the first row of the grid and select **Span 1 Bracing** from the droplist
- Repeat for the second and third rows of the panel, and then click **OK**.



	Between girders	Bracing run
	1 & 2	1:Span 1 bracing
	2 & 3	1:Span 1 bracing
	3 & 4	1:Span 1 bracing

- In the  treeview double click on the Span utility **Span 2**.
- In the Bracing Runs panel click in the Bracing Run cell in the first row of the grid and select **Span 2 Bracing** from the droplist.
- Repeat for the second and third rows of the panel, and then click **OK**.

Assigning the Bracing Assembly to Supports

- In the  treeview double click on the Support utility **End Pier** to open the Support dialog.
- In the Bracing panel click in the Support bracing cell in the first row of the grid and select **Support Bracing** from the droplist.
- Repeat for the second and third rows of the panel and then click **OK**.

Bracing		
Between girders		Support bracing
▶ 1 & 2		2:Support Bracing
2 & 3		2:Support Bracing
3 & 4		2:Support Bracing

- In the  treeview double click on the Support utility **Internal Pier 1** to open the dialog.
- In the Bracing panel click in the Support bracing cell in the first row of the grid and select **Intermediate Bracing** from the droplist.
- Repeat for the second and third rows of the panel, and then click **OK**.
- In the  treeview double click on the Support utility **Internal Pier 2** to open the dialog.
- In the Bracing panel click in the Support bracing cell in the first row of the grid and select **Intermediate Bracing** from the droplist.
- Repeat for the second and third rows of the panel, and then click **OK**.

Re-generating the Bridge with Stiffeners and Bracing

When all required bridge components have been defined, the revised steel composite bridge model that includes stiffeners and bracing can be generated.

- On the dialog that appears press **Generate**.

After a period of time the bridge is created with the required geometry, features, mesh, geometric, material and support attributes.

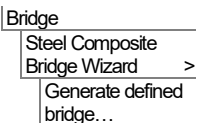

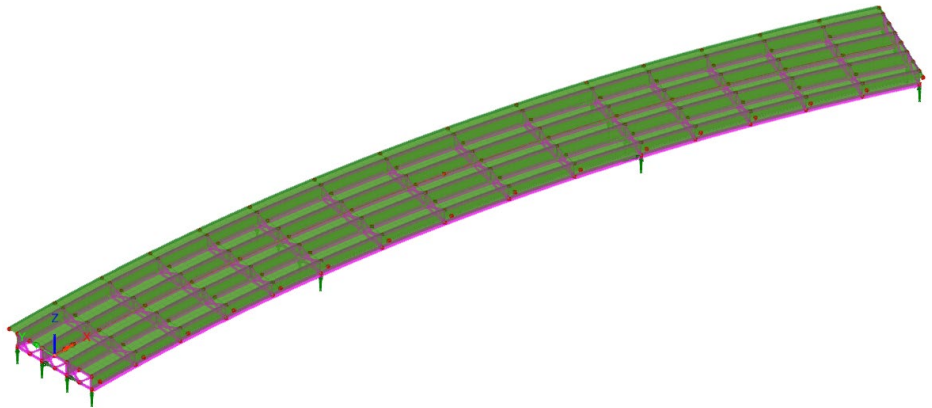

If the bridge generation fails...

If the bridge cannot be generated from the data defined, information relating to the nature of the error encountered will be displayed on screen. Any issues should be corrected by opening the relevant bridge wizard utilities, then saving the model and attempting to re-generate the bridge. If the errors cannot be identified or overcome, a replacement model can be created from a supplied file in order to solve and view results.

Creating a replacement model

A script file is provided to allow you to create a replacement model and view and investigate all utilities and attributes created by the wizard. You may download this file from the user area of the LUSAS website.



steel_composite_bridge_wizard_braced.lvb

Creating a replacement model with bracing

- Enter a file name of **steel_composite_bridge**
- Use the default **User-defined** working folder.
- Ensure an Analysis type of **Structural** is set.
- Ensure an Analysis category of **3D** is set.
- Click the **OK** button.



Note. There is no need to enter any other new model details when the intention is to run a script to build an initial model, since the contents of the script will overwrite any other settings made.

File
New...

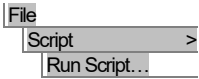

-  To create the model, open the read-only file **steel_composite_bridge_wizard_braced.lvb** that was downloaded and placed in a folder of your choosing.





Note. The supplied model includes all bridge wizard utilities, and the bracing and stiffeners as defined in the previous section. Design details are present but not activated.

- If you have needed to open the replacement model, please continue at the previous heading “Re-generating the Bridge with Stiffeners and Bracing”.

When the bridge has been successfully generated

If necessary,

-  Choose an isometric view of the model to see the generated features, mesh and supports.
-  Turn on fleshing.
-  Turn on ‘Fleshing all transparent’.



Note. Pressing the 'Generate' button deletes any previously created model geometry created by the wizard and re-creates a new model, including bracing and stiffeners, based on the latest data that exists in the Utilities  treeview.

Applying Loading

In this model only the self weight of the structure will be considered.

- In the  treeview, right-click on **Loadcase 1** and select **Gravity**. A blue arrow is shown on the Loadcase 1 icon to indicate that gravity loading has been assigned.

Save the model



 Save the model.

Running the Analysis

With the model loaded:

 Select the **Solve Now** button from the toolbar and click **OK** to run the analysis.

A LUSAS Datafile will be created from the model information. The LUSAS Solver uses this datafile to perform the analysis.

If the analysis is successful...

Analysis loadcase results are added to the  Treeview

Addition files will be created in the directory where the model file resides, including:



- steel_composite_bridge.out** This output file contains details of model data, assigned attributes and selected statistics of the analysis.
- steel_composite_bridge.mys** This is the LUSAS results file which is loaded automatically into the  Treeview to allow results processing to take place.

If the analysis is unsuccessful...

Return to the previous section entitled 'Creating a replacement model with bracing'.

Viewing the Results

Analysis loadcase results are present in the  Treeview and by default Loadcase 1 is set active.



By default, the deformed mesh is also shown. A review of the deformed mesh indicates that the shape is as expected.

- In the  Treeview, right click on the **Deformed mesh** layer and turn off its display.

Beam/Shell Slicing

The Slice Resultants Beams/Shells facility will now be used to review the results on the overall length of Girder 2. This allows the conversion of the results from a complex shell model into an equivalent beam analogy and permits results to be calculated at specified locations along the run of girders.

First, lines that represent the overall length of a run of girders need to be selected.

- In the  Treeview right click on the group **Girder Span lines** and choose as **Set as Only Visible**. This changes the display to only show the main span lines for each girder.
- In the  Treeview right click on the group **Girder 2** and choose as **Select members** to select the span lines for girder 2.

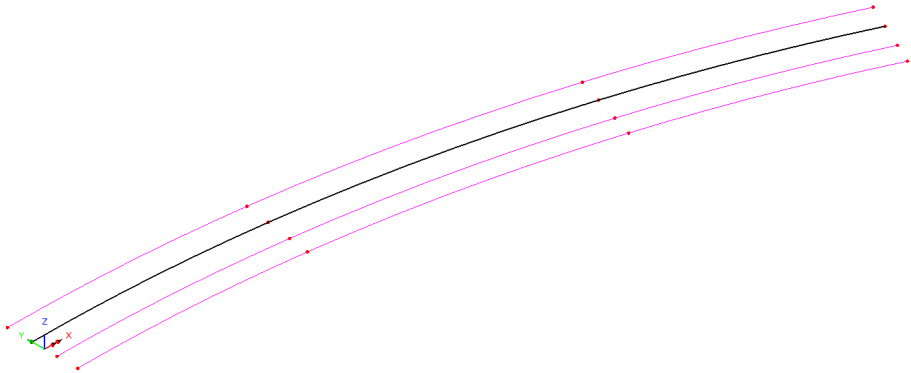

Utilities
 Slice Resultants
 Beams/Shells

The lines previously selected are shown in the dialog

- For the Slice locations, choose the **Constant spacing** option. Set the value as **10**.
- For the Slice Options, tick the **Slice width** check box and enter a value of **9**.



Note. Specifying an overall slice (that is centred on and perpendicular to the slicing path) limits the number of elements to include in the results beam/shell slice resultants calculations.

- Click **OK**.

Slice locations will be visualised on the model.

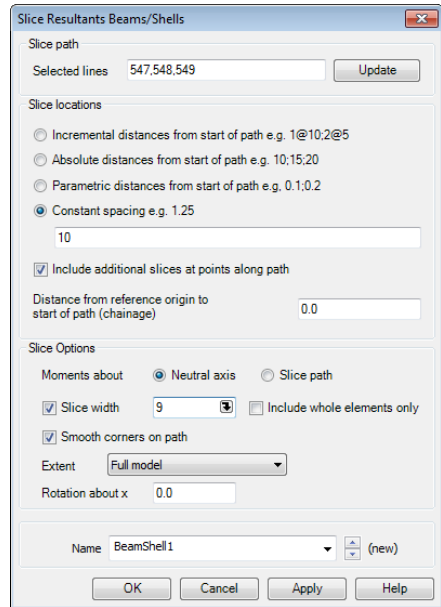

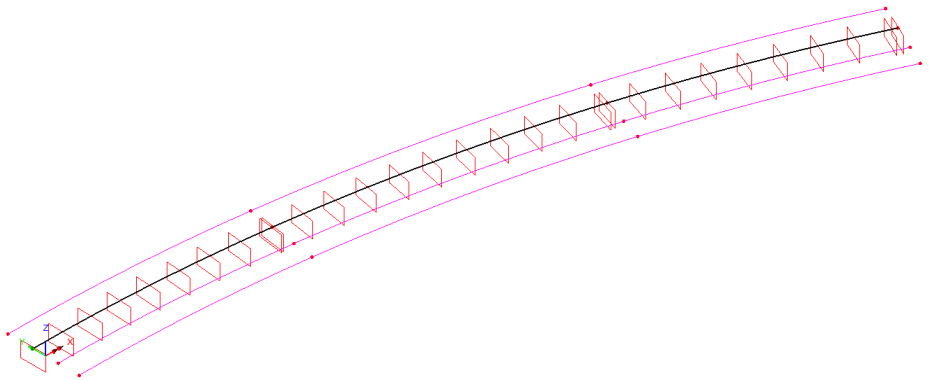

Viewing Results

- In the  Treeview right click on the group **Girder 2** and choose **Set as only visible**.

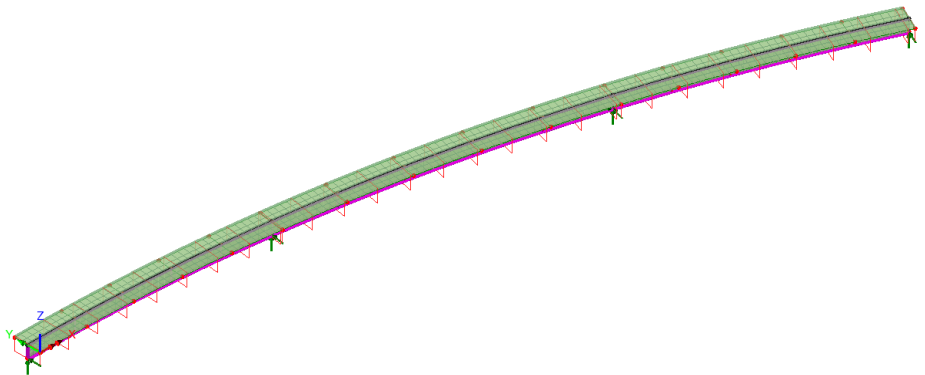

- In the  Treeview turn off the display of the **Mesh** layer.
- With no features selected, right-click in a blank region of the view window and select **Diagrams**. In the Entity droplist choose **Beam/Shell Slice Resultants**. In the component droplist choose **My**.
- Select the **Diagram display** tab and select the **Label font** option and set the size to be **20** and click **OK**.
- Select the **Scale** tab and ensure that **Use local scale** is set and then **Specify Magnitude** to be **20**
- When done, click **OK**.

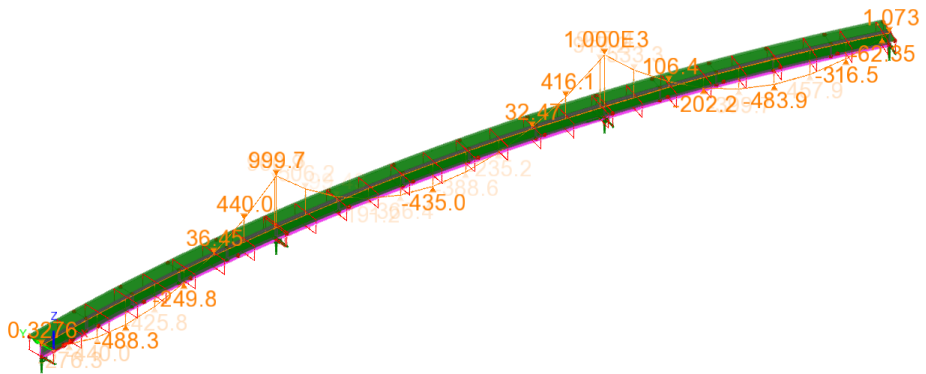

Save the model

File
Save



Save the model file.

Part 2: Defining design attributes in preparation for a design check

If your software licence supports the Composite Bridge Deck Design software option, it is possible to define design attributes on the ‘Composite I-girder Section’ dialog and the ‘Transverse Stiffener’ dialog, to allow a model to be created that suitable for a design check to supported design codes.



Note. Only the process of defining design attributes (which provide all design-related data not currently defined) is covered here in this ‘Steel Composite Bridge Wizard’ worked example. A separate worked example titled ‘Steel Composite Bridge Design Check’ shows how to carry out design checks on a similar model to this one.

The definition of the design attributes as described below assumes they are defined after building an initial analysis model, by editing the appropriate bridge wizard utility that is shown in brackets (...) in the Utilities treeview.

Step 1: Define the Bridge Design Girder Material

- In the Utilities treeview, edit the Section 1 internal utility.
- On the resulting dialog select the **Bridge design material** check box.
- From the droplist that is enabled select **New**
- On the Bridge Design Girder Material dialog, set the Slab concrete to be **4.0ksi**

- Change the Reinforcement grade to be **A615 Grade 60**
- Set the Steel girder grade to be **Grade 50**

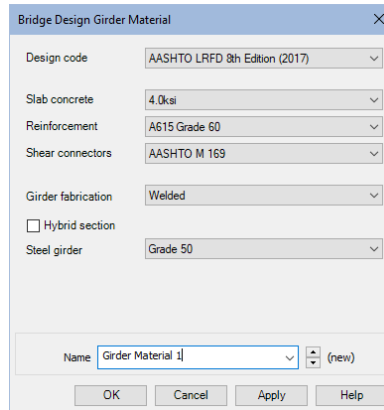

The screenshot shows the 'Bridge Design Girder Material' dialog box. It contains several dropdown menus and a checkbox. The 'Design code' is set to 'AASHTO LRFD 8th Edition (2017)'. 'Slab concrete' is '4.0ksi'. 'Reinforcement' is 'A615 Grade 60'. 'Shear connectors' is 'AASHTO M 169'. 'Girder fabrication' is 'Welded'. There is an unchecked checkbox for 'Hybrid section'. 'Steel girder' is 'Grade 50'. At the bottom, the 'Name' field is 'Girder Material 1' with a '(new)' indicator. Buttons for 'OK', 'Cancel', 'Apply', and 'Help' are at the bottom.

- Change the name to **Girder Material 1** and click **OK** to return to the Composite I-girder Section utility dialog.

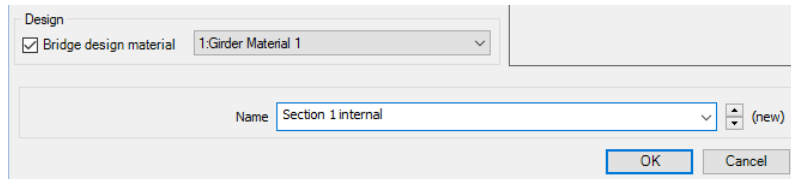



The screenshot shows the 'Composite I-girder Section' utility dialog box. The 'Design' section has a checked 'Bridge design material' checkbox and a dropdown menu showing '1:Girder Material 1'. The 'Name' field is 'Section 1 internal' with a '(new)' indicator. 'OK' and 'Cancel' buttons are at the bottom.



- Then click **OK** to close that dialog.



Note. If deck design is to be carried out a bridge design material attribute must be assigned to all Composite I-girder Sections. In this example the same bridge design material attribute is to be used for all the girders.

- In the Utilities  treeview, edit the  **Section 1 external** utility.
- On the resulting dialog select the **Bridge design material** check box.
- Ensure **Girder Material 1** is selected and click **OK**.
- Repeat the above sequence to edit and then define the same bridge design material for the **Section 2 internal** and **Section 2 external** utilities

Step 2: Define the Bridge Design Transverse Stiffener

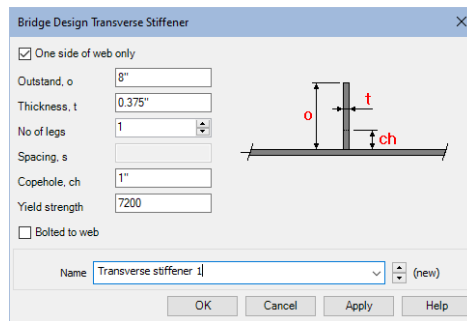

- In the Utilities  treeview, edit the  **Left of web stiffener** utility.
- On the resulting dialog select the **Bridge design stiffener** check box.

- From the droplist that is enabled select **New**.
- On the Bridge Design Transverse Stiffener dialog set select the **One side of web only** checkbox
- Enter an Outstand width of **8”**
- Enter a Thickness of **0.375”**
- Ensure the number of legs is set to **1**
- Enter a Copehole size of **1”**
- Enter a Yield Strength of **7200**
- Ensure that the ‘Bolted to web’ option is not checked (ticked).

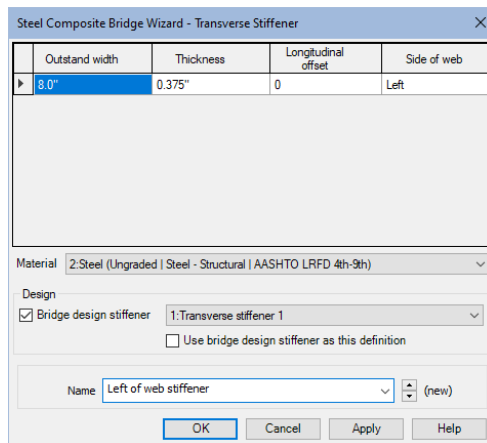

- Change the name to **Transverse Stiffener 1** and click **OK** to return to the Transverse Stiffener utility dialog.



- Then click **OK** to close that dialog.
- In the Utilities  treeview, edit the  **Right of web stiffener** utility.
- On the resulting dialog select the **Bridge design stiffener** check box.
- Ensure **Transverse Stiffener 1** is selected and click **OK**, and **OK** to close the parent dialog.

Re-generating the bridge with design details present

Once all design attributes have been defined and referenced by the relevant utilities the model can be re-generated by the bridge wizard.

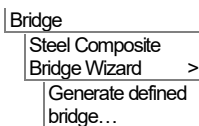

- On the dialog that appears press **Generate**.

After a period of time the bridge is recreated with the selected girder showing the same results obtained but with all information present to allow the model to be developed further and a design check to be carried out.



Note. When Bridge Design Material is specified the model view will also include section slice planes, and the Utilities  treeview will include Composite Design Member entries.



Note. Slice planes are created for each design location specified for a Composite Design Member and for any required interpolated locations. By default, slice local axes, planes and labels are drawn in red, but these and other visualisation settings relating to slice axes, slice planes and slice labels can be specified from the Utilities layer properties dialog.

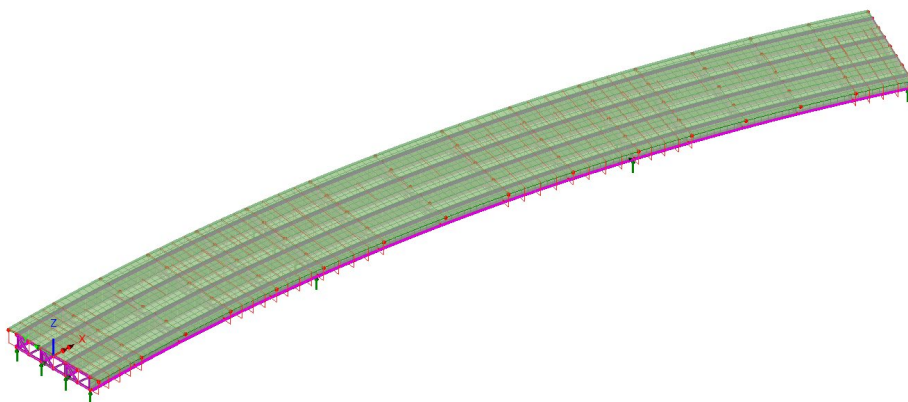

Re-applying Loading

Note that any previously applied loading will be lost when a model is re-generated, so the previously assigned self-weight of the structure will need to be added again.



- In the  treeview, right-click on **Loadcase 1** and select **Gravity**. A blue arrow is shown on the Loadcase 1 icon to indicate that gravity loading has been assigned.

With the model loaded:



Select the **Solve Now** button from the toolbar and click **OK** to run the analysis.

Once solved, simplify the display to only show Girder 2 and its slice planes:

- In the  treeview right-click on **Girder 2** and choose **Set as Only Visible**
- In the  treeview double-click the **Utilities** entry. Select the **Composite Design Member** tab and uncheck **Girder 1**, **Girder 3** and **Girder 4** to turn off the display of the slice planes for these members.

At this stage the diagram will show results of M_y for the previously defined slice locations at 20m spacing, with the design slice locations superimposed on top.

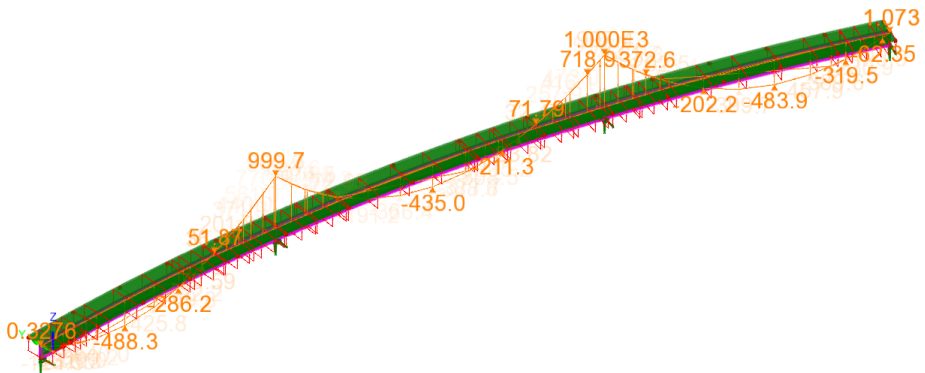

To view a diagram of M_y for only the design slice locations:

- In the  treeview, near the bottom, right-click on the **BeamShell1** entry and choose **Invisible**.

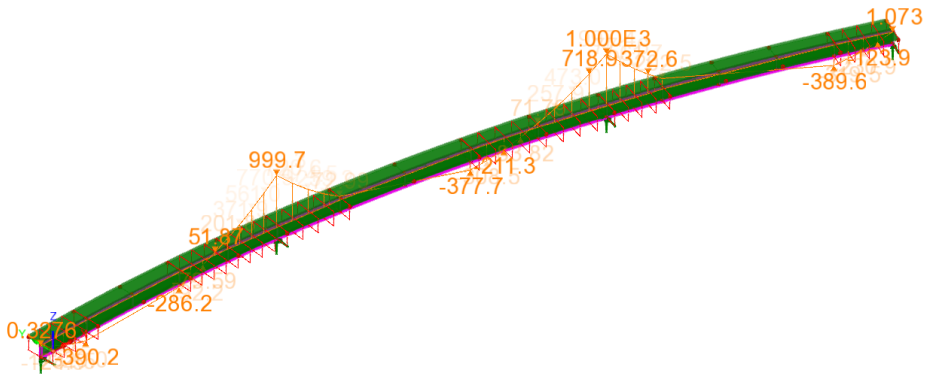

Notes on creation and additional editing of the model

Models are always re-generated from the latest bridge wizard data that exists in the Utilities  treeview. Once a bridge model has been created, additional loading and analyses may be defined.

Note that attributes automatically created from the bridge wizard utilities (that were created from running Steel Composite Bridge Wizard) are ‘protected’ and cannot be assigned, de-assigned, edited or deleted unless the ‘Allow modification of LUSAS-generated attributes’ option is selected from the Attributes tab of the Model properties dialog.



Caution. Models are always re-generated from the latest bridge wizard data that exists in the Utilities  treeview. Re-generating a bridge model using the steel composite bridge wizard will cause any additional changes that have been made to the model since the wizard was last run. Examples of data lost include the addition of extra geometry, the assignment of gravity and other loading, and additional analyses etc.

The Bridge Wizard Toolbar



Note. For those familiar with the bridge wizard operations, and to provide an alternative to picking the Steel Composite Bridge Wizard menu selections as described in this example, a Bridge Wizard toolbar can be enabled in LUSAS Modeller. To do this:

- Select the **View > Toolbars...** menu command, select the **Toolbars** tab, select the **Bridge Wizard** option in the list and click **Close**

The following toolbar will appear and can be docked into the main toolbar menu.



The toolbar buttons are named, from left to right:

- Composite I-Girder Section
- Girder
- Span
- Support
- Bridge
- Stiffener
- Bracing Assembly
- Bracing Run
- Generate bridge model